



CFK

Burner control system

CFK

Burner control system

Contents

Description	2
Features	2
Technical specifications	4
Functioning	7
Applications	10
Configuration	14
Fieldbus control	19
Installation warnings	20
Ordering information	21
Accessories	22
Standard and approvals	23

Description

CFK device is designed to control gas burners in accordance with norm EN 746-2, for intermittent or continuous operation. Different versions are available and many parameters are configurable to have the best solution for every plant.

Features

- Available in BASIC or FULL version.
- Flame detection via either UV cell or ionization rod, even shared with ignition.
- Possibility to use either electronic or winding transformers.
- Burner status is visualized via a 7-segment display and led-bar.
- Parameter setting via PC and USB device.
- Provided with advanced self-diagnostic to assure a safe operation.
- Voltage supplied to loads equal to voltage supplied to the device.
- Housing available in polymeric material or die-casted aluminium.
- Supervision of the burner can be implemented by traditional electrical wiring, or through built-in communication line.
- Designed and manufactured according to EN 298.



WARNING

This control must be installed in compliance with the rules in force.

Features of FULL and BASIC versions:

		FULL	BASIC
1ST Fuel valve	Output for (pilot burner) fuel valve.	●	●
2ND Fuel valve	Output for main burner fuel valve.	●	⊗
Air output	Output for blower or air valve.	●	⊗
Air pressure switch	Input from low air pressure switch.	●	⊗
Burner on	Output activated when burner is running.	●	●
Burner lockout	Output activated while in lockout.	●	●
Remote reset	Input for reset from lockout.	●	●
Remote air control	Input for remote control of air output.	●	⊗
Start input 1	Input to start/stop the burner.	●	●
Start input 2 Hi-temp bypass 2n Flame sensor	Configurable input: to start/stop the main burner or for indirect flame surveillance above 750°C or for independent main flame sensor.	●	⊗
Supply monitor	Protection against over/undervoltage.	●	●
TraxBus	Interface for communication fieldbus.	●	●
Infrared	Local configuration/control with smartphone app and USB device	●	●
Diagnostic	Display reports cycle status, lockouts and failures.	●	●
Life counter	Counter for ignition cycles and working times.	●	●
Log memory	Last 60 lockouts, failures and manual shutdowns.	●	●

● available

⊗ not available

Technical specifications

Voltage	230 – 115 VAC 50/60 Hz (-15/+10%)
Process inputs	230 – 115 – 48 – 24 VAC (max. 3 mA)
Power absorption	6 VA
Enclosure	IP64
Fuse (replaceable)	3 A fast 5x20
Available load for Output	250 VAC, 2 A $\cos\phi=0,7$
Minimum ionization current	> 1 μ A (current limitation 1mA)
Detector line length	30 m max. (2 m in case of single rod)
Detector voltage	250 VAC
Detector insulation	> 50 M Ω
Working temperature	-20°C / +60°C
Flame detection	ionization rod or UV cell
Overall Dimension	200 x 120 x 71 mm
Weight	850 gr (plastic case) 1200 gr (aluminium case)

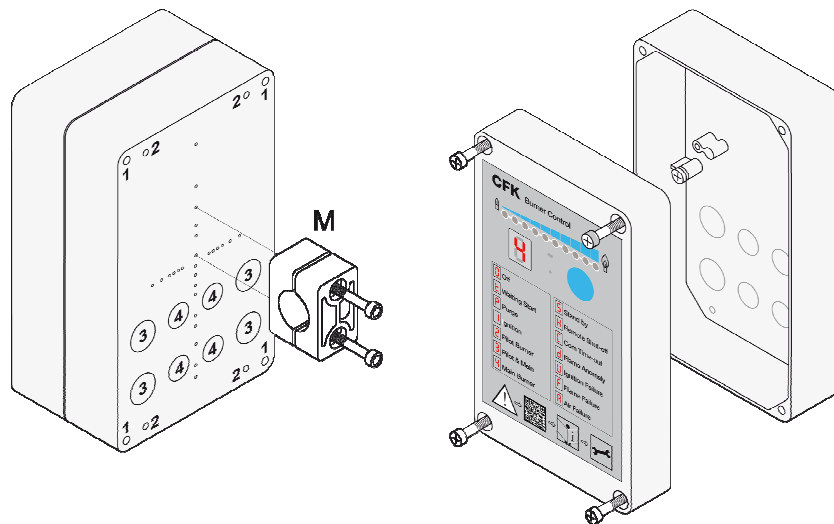

Fig.1

- | | |
|---|--------------|
| 1) EXTERNAL FITTING HOLES (4)
4.2 mm self tapping or M5 thread forming screw | 106 x 186 mm |
| 2) BREAKABLE FITTING HOLES (4)
4,0 mm diameter | 77 x 182 mm |
| 3) BREAKABLE HOLES FOR WIRING (4)
suitable for PG11 cable gland | Ø 19,0 mm |
| 4) BREAKABLE HOLES FOR WIRING (4)
suitable for PG9 cable glands | Ø 15,5 mm |

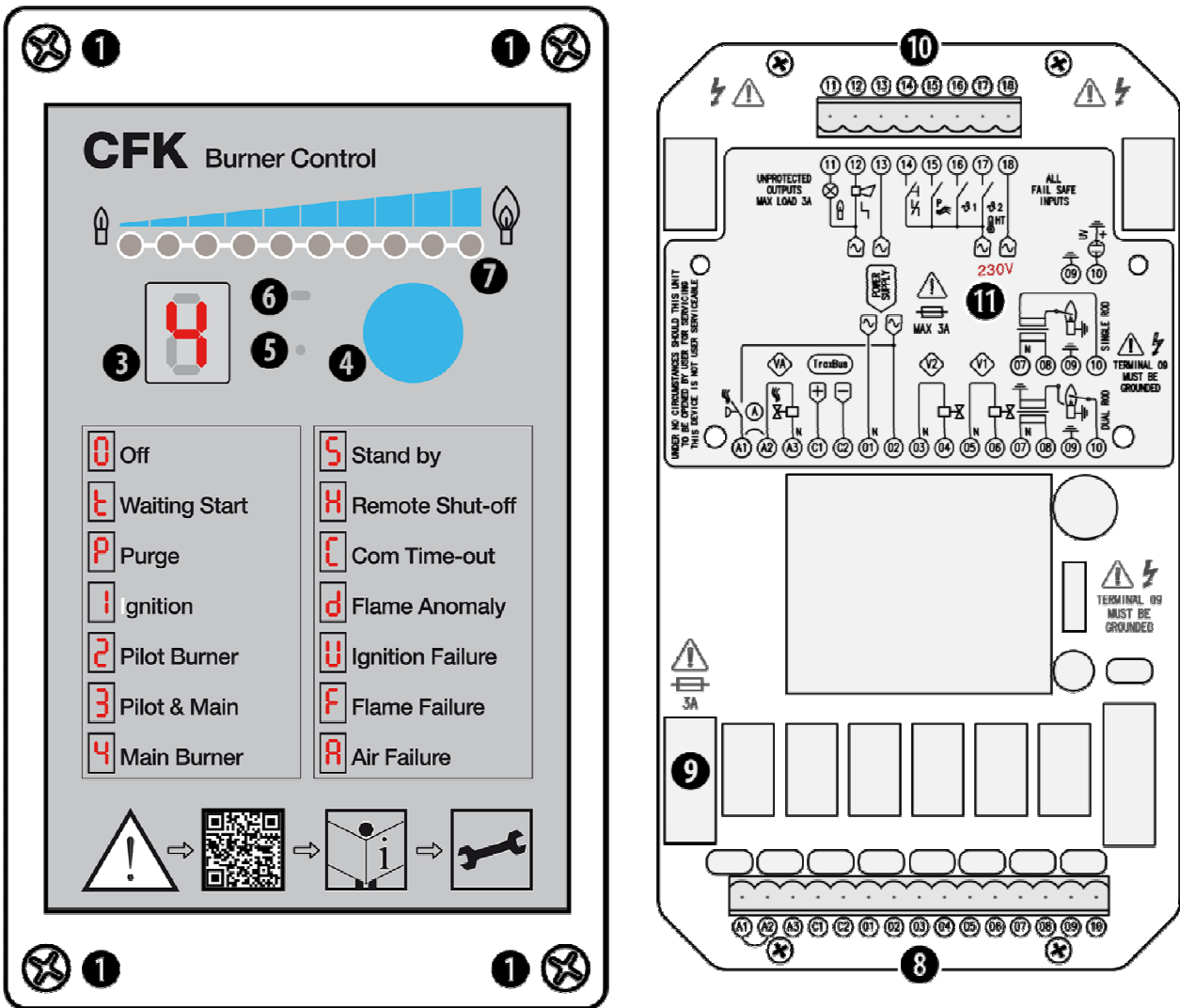

Fig.2

FRONT PANEL

- FITTING SCREWS 1
- FLAME SIGNAL BARGRAPH (RED) 2
- STATUS DISPLAY 3
- RESET / SHUTOFF BUTTON 4
- COM INDICATOR (YELLOW) 5
- AIR OUTPUT INDICATOR (BLUE) 6
- HI-TEMP BYPASS INDICATOR (RED) 7

INTERNAL

- 8 MAIN TERMINAL BOARD
- 9 POWER SUPPLY FUSE 1
- 10 INPUT/OUTPUT TERMINAL BOARD
- 11 INPUT VOLTAGE SPECIFICATION

1 ULTIMATE PROTECTION AGAINST DANGEROUS CONDITIONS BY MEANS OF INTERNAL, NON REPLACEABLE 5A SAFETY FUSE

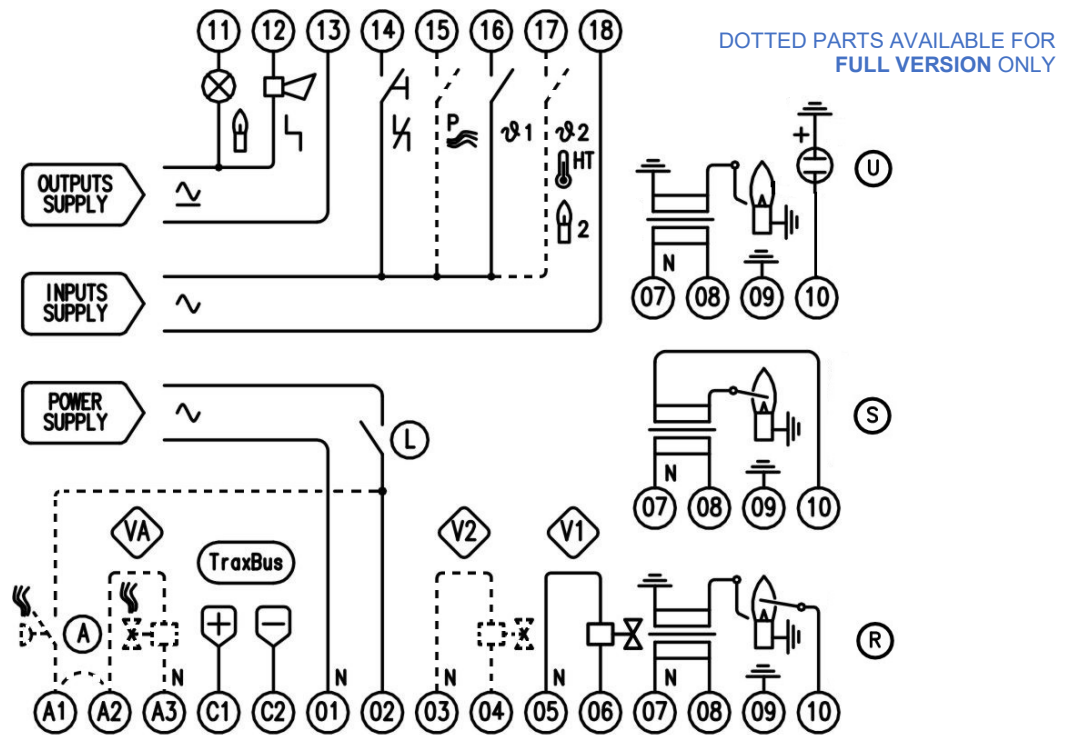

Fig.3

SYMBOL USED:

A	AIR PRESSURE SWITCH		RESET INPUT
L	EXTERNAL LIMITS		AIR CONTROL INPUT
VA	AIR VALVE (FAN)		ON/OFF START INPUT
V1	1 ST STAGE FUEL VALVE (PILOT)		MAIN START INPUT
V2	2 ND STAGE FUEL VALVE (MAIN)		BURNER ON
U	UV SENSOR		BURNER LOCKOUT
R	DUAL ROD		HI-TEMP BYPASS INPUT
S	SINGLE ROD		

WIRING TERMINALS:

01	POWER SUPPLY – NEUTRAL	N
02	POWER SUPPLY – PHASE	
03	2 ND FUEL VALVE (MAIN) – NEUTRAL	N
04	2 ND FUEL VALVE (MAIN) – PHASE	V2
05	1 ST FUEL VALVE (PILOT) – NEUTRAL	N
06	1 ST FUEL VALVE (PILOT) – PHASEV1	
07	IGNITION TRANSFORMER – NEUTRAL	N
08	IGNITION TRANSFORMER – PHASE	
09	GROUND	
10	FLAME DETECTOR INPUT	ROD UV
11	OUT BURNER ON	
12	OUT BURNER LOCKOUT	
13	OUTS COMMON RETURN	
14	IN REMOTE RESET	
15	IN AIR CONTROL	
16	IN START INPUT 1	
17	IN START INPUT 2 HI BYPASS FLAME 2	
18	INS COMMON RETURN	
C1	COM INTERFACE – POSITIVE	+
C2	COM INTERFACE – NEGATIVE	-
A1	LOW AIR PRESSURE SWITCH	A
A2	AIR VALVE OUTPUT – PHASE	VA
A3	AIR VALVE OUTPUT – NEUTRAL	N

Functioning

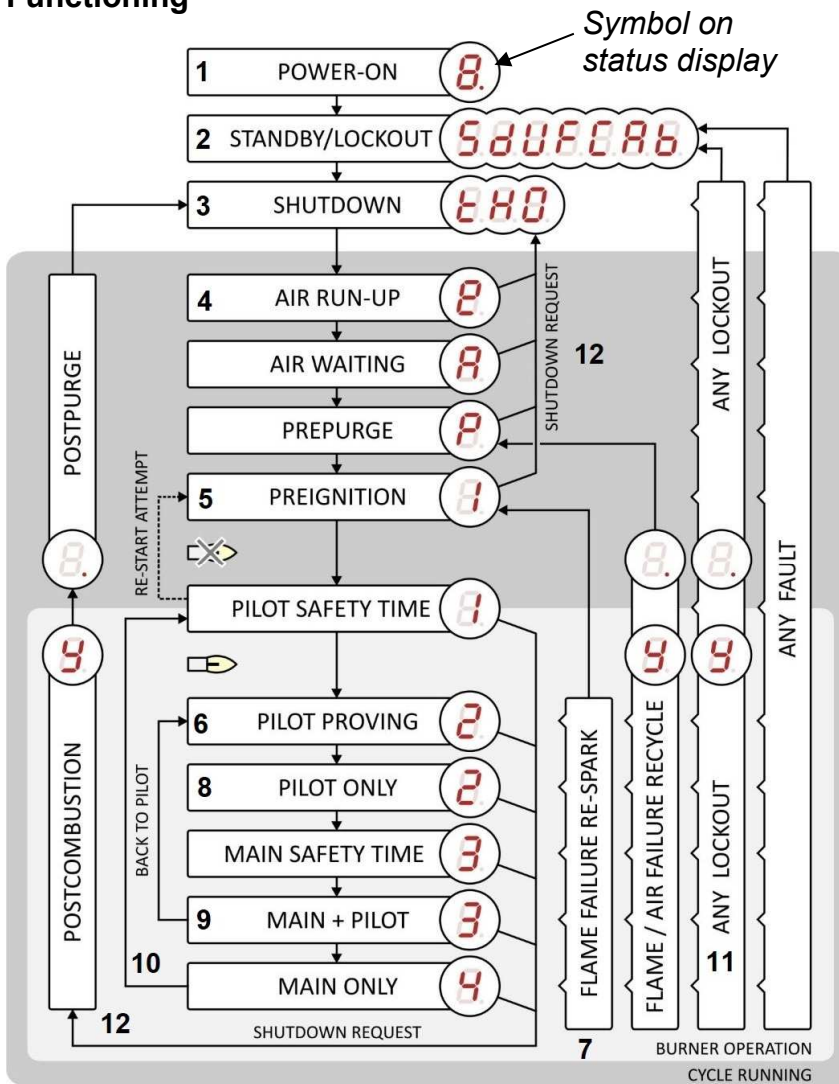

Fig. 4

PROGRAM SEQUENCE OF FULL VERSION:

- 1) A **self test** is performed at power-on, once successfully completed burner control is ready for next point.
- 2) If the unit has been turned off while in **lockout** or parameter 101 has been set to **standby**, it will be necessary to push the reset button or issue a fieldbus reset command; otherwise burner go directly to point 3.
- 3) The burner remains in **shutdown** until the Start input 1 is open. When contact Start input 1 is closed, ignition sequence starts.
- 4) In accordance with parameter 301, 302 and 303 air valve or fan is activated, air pressure switch is monitored and **purge** is performed. In the meanwhile, the absence of **Flame anomaly** is verified.
- 5) Ignition device is activated and verified, then the pilot gas valve is open.
- 6) If the flame is detected within the **safety time**, pilot gas valve stay opens.
- 7) If no flame is detected within the safety time, a lockout occurs. Depending on parameter 403 the unit could carry out up to three further **start-up attempts**.
- 8) In accordance with parameter 501 and 502, after the pilot proving time the main gas valve opens.

- 9) In case of intermittent pilot, at the end of 2nd safety time the pilot gas valve is turned off.
- 10) **Main gas valve can** be controlled by START 2.
- 7) **Flame failure** during operation leads to lockout, ignition restoration or recycle, depending on parameter 504.
- 11) **Air failures** during operation leads to immediate lockout or recycle, depending on parameter 507.
- 12) **Shutdown request** (Start 1 open or fieldbus command) will turn off the burner, waiting for allowed post-combustion and optional post-purge. A **minimum combustion time** can be set so that burner works for a minimum time, even if the Start 1 is switched off or an halt command is received.

HIGH-TEMPERATURE FLAME BYPASS

When **temperature equipment is above 750°C**, flame supervision is no more necessary (see EN 746-2) so a flame-bypass request can be issued through terminal 17. Receiving a bypass request, the internal flame control system is bypassed and the fuel valves are opened without flame supervision, the burner is turned on directly (no safety time, no ignition transformer). When the temperature in the furnace drops below 750°C, the flame-bypass request must be released.













RESET

A reset action is supposed to be a clear defined manual action. An automatic reset is not allowed by EN 13611. When reset action is initiated from remote by means of **reset input** at terminal 14 or through the **fieldbus control**, actual status and relevant information of the process shall be visible to the user. CFK limits the maximum number of remote resets to 5 actions within 15 minutes, if this limit is exceeded, a lockout occurs and **local** reset is necessary.









STATUS DISPLAY

The Status Display [fig. 2–point 3] gives an indication about the working condition of both the burner and the equipment.



CYCLE

	MANUAL SHUTDOWN UNIT HAS BEEN PUT OUT OF SERVICE FROM PUSH BUTTON. PUSH AGAIN TO RESTORE.		IGNITION 1 ST SAFETY TIME. BURNER IGNITION TRIAL WITH PILOT FUEL VALVE OPEN.
	START INPUT SHUTDOWN BURNER HAS BEEN TURNED OFF BY LOCAL START INPUT 1.		PILOT BURNER ON PILOT FUEL VALVE IS ON, OPERATING POSITION FOR SINGLE STAGE BURNERS.
	REMOTE SHUTDOWN BURNER HAS BEEN TURNED OFF BY REMOTE CONTROL THROUGH FIELDBUS.		PILOT & MAIN BURNER ON INTERMITTENT PILOT (OR 2 ND SAFETY TIME FOR INTERRUPTED PILOT BURNERS).
	AIR RUN-UP DELAY OPTIONAL WAITING TIME FOR AIR REACHING RATED FLOW. AIR SIMULATION TEST.		MAIN BURNER ON ONLY MAIN FUEL VALVE IS ON (DUAL STAGE WITH INTERRUPTED PILOT).
	AIR PRESSURE WAITING WAITING FOR RATED AIR PRESSURE BEFORE CONTINUING WITH PURGE.		POSTCOMBUSTION WAITING FOR FLAME QUENCHING AFTER LOCKOUT OR SHUTDOWN REQUEST.
	PREPURGE PURGE OF COMBUSTION CHAMBER OR MIN TIME FOR ILLEGAL FLAME PROVING.		POSTPURGE PURGE OF COMBUSTION CHAMBER, SHOWN TOGETHER WITH ASSOCIATED CODE.

LOCKOUTS

	STANDBY WAITING FOR RESET WHEN PROGRAMMED FOR STANDBY MODE AT POWER-ON.		IGNITION FAILURE NO FLAME DETECTED AT THE END OF 1 ST SAFETY TIME (IGNITION TRIAL).
	FLAME ANOMALY FLAME DETECTION DURING PREPURGE OR POSTPURGE (AFTER POSTCOMBUSTION).		FLAME FAILURE FLAME QUENCHING DURING NORMAL BURNER OPERATION.
	AIR FLOW SIMULATION AIR PRESSURE DETECTED WHEN AIR OUTPUT IS OFF.		AIR FAILURE AIR PRESSURE FAILURE DURING PURGE OR DURING NORMAL BURNER OPERATION.
	RESET / COMMAND ERROR ILLEGAL REMOTE COMMAND OR TOO MANY RESETS (MORE THAN 5 WITHIN 15 MIN).		COMMUNICATION TIMEOUT MISSING COMMANDS FROM SUPERVISOR OR EXPANSION BOARD FAILURE.

WARNINGS

	SELF-TEST VERIFICATION AND INITIALIZATION OF SYSTEM COMPONENTS AT POWER-ON.		CONFIGURATION UNIT IN CONFIGURATION MODE THROUGH COMMUNICATION LINK.
---	---	---	--

FAILURES



IGNITION OUTPUT FAILURE

IGNITION DEVICE OUTPUT REMAINS INACTIVE.



FUEL VALVE OUTPUT FAILURE

1ST STAGE (PILOT) FUEL VALVE OUTPUT REMAINS INACTIVE.



FUEL VALVE OUTPUT FAILURE

2ND STAGE (MAIN) FUEL VALVE OUTPUT REMAINS INACTIVE.



PROCESS INPUTS FAILURE

UNRELIABLE OPERATION OF PROCESS INPUTS TERMINALS 14, 15, 16, 17.



OUTPUT RELAYS FAILURE ¹

SHORT CIRCUIT ON OUTPUT RELAY CONTACT LOADS DISCONNECTED BY SAFETY RELAY.



UNDERVOLTAGE

POWER SUPPLY VOLTAGE TOO LOW SYSTEM REMAINS ACTIVE.



OVERVOLTAGE

POWER SUPPLY VOLTAGE TOO HIGH FUSE INTENTIONALLY BROKEN AFTER 5".



PROGRAM ERROR

WRONG PROGRAM SEQUENCE. UNSAFE OPERATION STOPPED.



MEMORY ERROR

DATA CORRUPTION. CONFIGURATION ERROR.



TIMEBASE ERROR

MISMATCH BETWEEN 1ST AND 2ND INTERNAL TIMEBASE GENERATORS.



SYSTEM ERROR

MICROPROCESSOR IS NOT OPERATING PROPERLY.



FLAME INPUT FAILURE

FLAME SENSOR REVERSED POLARITY OR UNRELIABLE FLAME AMPLIFIER.



RESET FAILURE

PUSH BUTTON OR REMOTE RESET ACTIVE FOR LONG TIME (MORE THAN 10 SECONDS).



MASTER SAFETY RELAY FAILURE ¹

SHORT CIRCUIT ON SAFETY RELAY CONTACT. OUTPUTS RELEASED.

¹ A PERMANENT FAILURE TO THE RELAY CONTACT MAY CAUSE THE MAIN FUSE TO BLOWN, AS A SAFETY MEASURE TO PREVENT DANGEROUS CONDITIONS. IN SUCH CASE THE UNIT MUST BE RETURNED TO FACTORY FOR SERVICING.

FLAME SIGNAL BARGRAPH

The flame signal bargraph [fig. 2–point 3] reports the strength of flame signal detected by the sensor connected at terminal 10. Full scale, 100% corresponds to a flame signal of 30 μ A approx.

When flame is detected, but the signal is below the sensitivity threshold (parameter 404 or 503 - 1 to 9 μ A), one of the first four indicators blinks.

The last led (full scale) is turned on, when the flame-bypass is activated by input 17 (parameter 004).

Applications

SINGLE STAGE BURNER

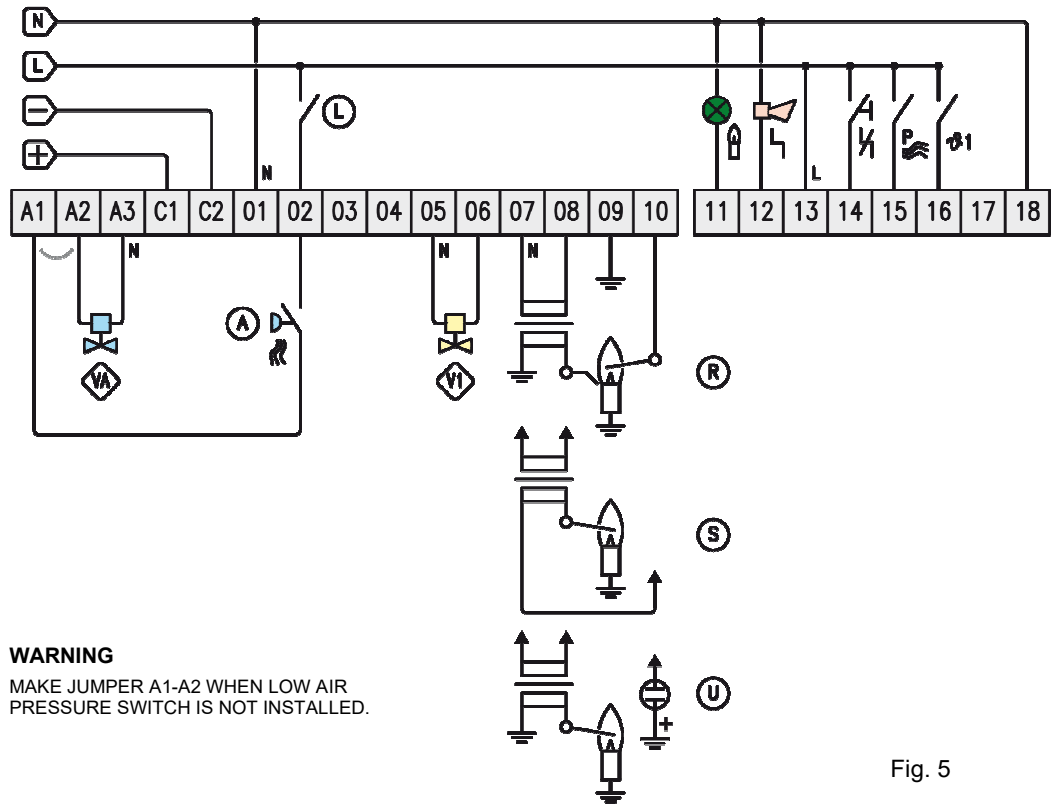

Fig. 5

	EXTERNAL LIMITS		RESET INPUT
	LOW AIR PRESSURE SWITCH		AIR CONTROL INPUT
	AIR VALVE		ON/OFF START INPUT 1
	PILOT GAS VALVE		BURNER ON
	DUAL ROD CIRCUIT		BURNER LOCKOUT
	UV SENSOR		SINGLE ROD CIRCUIT

Turn ON/OFF the burner by means of Start input at terminal 16 or through remote fieldbus command.

A flame anomaly test is carried out during pre-purge.

Air simulation test is carried out before activating the air output [VA] if enabled.

The fuel valve [V1] will be activated only if the ignition device is detected during pre-ignition time.

The fuel valve remains open during the programmed 1st safety time, if a valid flame signal is detected within the safety time the valve is kept open: the burner is on and after the pilot proving time the contact at terminals 11 will be closed (burner on).

If no flame is detected the system will lockout and contact at terminals 12 will be closed (lockout).

In accordance with EN 746-2 and EN 676, up to 4 ignition attempts are allowed if the safety is not impaired.

Push the front panel button or activate the input at terminal 14 to reset from lockout (will take place at release). Flame quenching during burner operation will force the system to lockout, recycle or ignition restoration. To put the burner out of service (manual shutdown) push the front panel button during the operating cycle. A post-combustion time (max 20 seconds) is allowed after a lockout or shutdown request, followed by post-purge.

The air output [VA] behavior is configurable for each cycle step, providing also cooling and purging processes; this output is monitored through the low air pressure switch [A].

UV sensor or ionization rod can be used for flame detection.

It's possible to share a single rod for ignition and flame detection.

DUAL STAGE BURNER

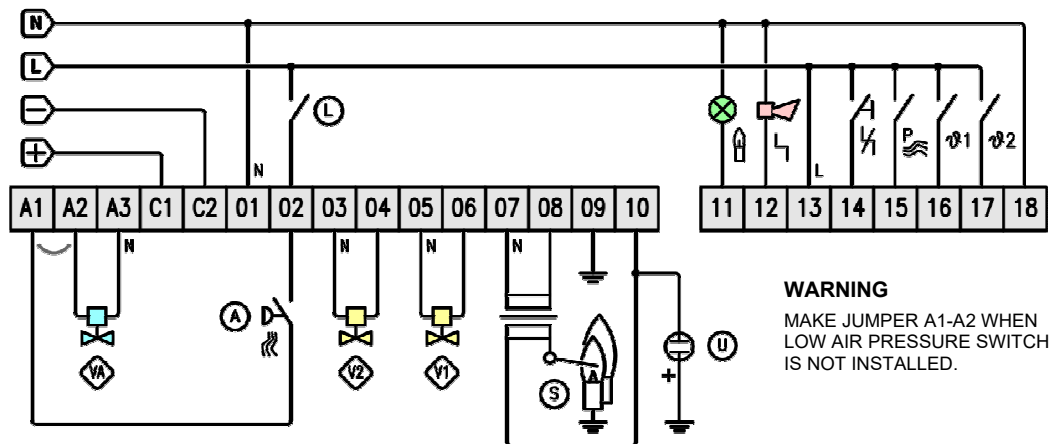

Fig.6

	EXTERNAL LIMITS		RESET INPUT
	LOW AIR PRESSURE SWITCH		AIR CONTROL INPUT
	AIR VALVE		ON/OFF START INPUT 1
	PILOT GAS VALVE		MAIN THERMOSTAT INPUT
	MAIN GAS VALVE		BURNER ON
	UV SENSOR (MAIN)		BURNER LOCKOUT
	SINGLE ROD CIRCUIT (PILOT)		

Turn ON/OFF the burner by means of Start input at terminal 16 or through remote fieldbus command.

Depending on configuration, the pilot burner could be:

- INTERRUPTED - extinguished at the end of the second safety time.
- ALWAYS ON - shut off simultaneously with the main flame.

Flame detection options:

- A single flame detector monitors both the pilot and main burner.
PURSUANT TO EN 746-2: A SINGLE COMMON FLAME SAFEGUARD IS ALLOWED FOR BURNERS THAT GUARANTEE STABLE COMBUSTION THROUGHOUT THE RANGE OF REGULATION AND ARE ON THE SAME AIR/GAS RATIO CONTROL SYSTEM, ARRANGED ADJACENT AND IN SUCH WAY THAT, IF ONE OF THEM IS EXTINGUISHED, IT IS RE-IGNITED QUICKLY AND SMOOTHLY BY THE FLAME FROM THE NEXT BURNER.
- Pilot and main flame detected by two independent sensors wired at same input.
PURSUANT TO EN 746-2: WHEN TWO INDEPENDENT SENSORS SHARES THE SAME FLAME AMPLIFIER INPUT, THE MAIN FLAME SENSOR SHALL BE SO POSITIONED THAT IT CANNOT IN ANY CIRCUMSTANCES DETECT THE PILOT FLAME.

Both UV detector or ionization rod can be used for pilot and main burner.

Once the pilot burner has started up, the main burner can be controlled by means of thermostat input at terminal 17 or through fieldbus command.

Turning off the main burner when the pilot burner is operating in INTERRUPTED mode will lead to a new burner ignition trial (1st safety time) including spark generation.

The air output operation is configurable during the whole cycle, providing also cooling and purging processes.

See SINGLE STAGE BURNER description for process input description.

HIGH TEMPERATURE FLAME SURVEILLANCE BYPASS

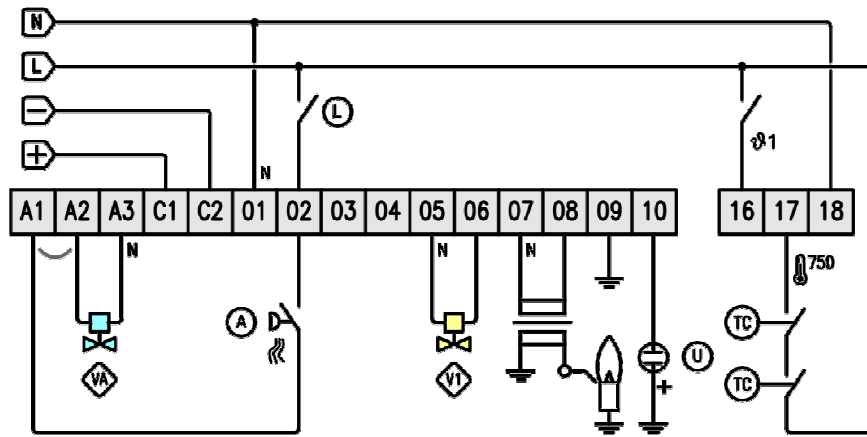

WARNING
 MAKE JUMPER A1-A2 WHEN LOW AIR
 PRESSURE SWITCH IS NOT INSTALLED.

Fig.7

- | | | | |
|--|-------------------------|--|----------------------|
| | EXTERNAL LIMITS | | START INPUT 1 |
| | LOW AIR PRESSURE SWITCH | | HI TEMP BYPASS INPUT |
| | AIR VALVE | | TEMPERATURE MONITOR |
| | GAS VALVE | | UV SENSOR |

When the burner is operating in combustion chamber having walls above 750°C, bypass of flame surveillance is possible by means of specific contact at input terminal 17. Signal at terminal 17 must be configured to manage high temperature bypass (default option is Thermostat 2). The last indicator of the flame signal bar-graph is blinking and the flame signal strength is not reported.

Flame surveillance must be active when the temperature in the combustion chamber is below 750°C.

In high temperature mode the fuel valves are opened without flame surveillance. Indirect control of flame provided by suitable external temperature monitor. Any failure to temperature monitor or sensor must release the bypass contact.

The burner is turned on without 1st safety time when the high temperature mode is active. Flame simulation is not verified during pre-purge and the ignition transformer is not energized, no ignition spark generated, in order to provide reliable operation for flameless burners.

The only reason to activate high temperature mode is to improve system availability, ignoring false flame detection that may occur at high temperatures.

The air output operation is configurable during the whole cycle.
 See SINGLE STAGE BURNER description for process input description.

DUAL STAGE BURNER WITH INDEPENDENT FLAME SENSOR

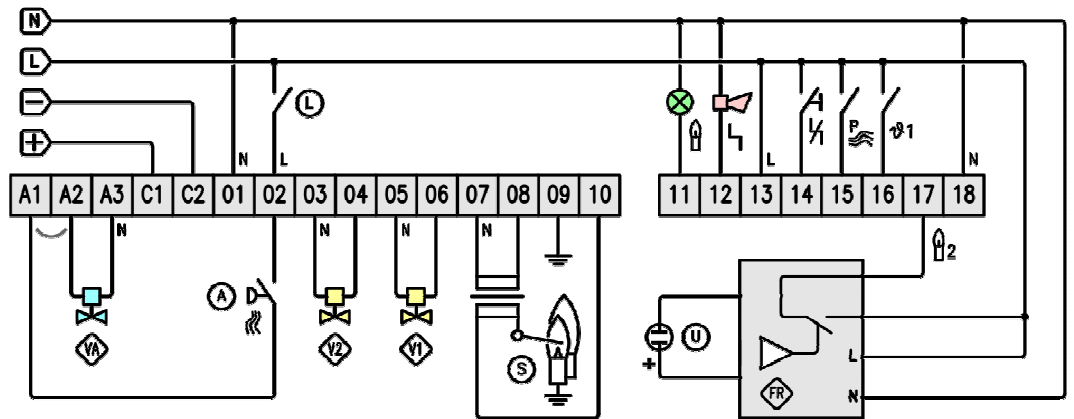

WARNING
 MAKE JUMPER A1-A2 WHEN LOW AIR PRESSURE SWITCH IS NOT INSTALLED.

Fig.8

	EXTERNAL LIMITS		RESET INPUT
	LOW AIR PRESSURE SWITCH		AIR CONTROL INPUT
	AIR VALVE		ON/OFF START INPUT 1
	PILOT GAS VALVE		MAIN BURNER FLAME INPUT
	MAIN GAS VALVE		BURNER ON
	SINGLE ROD CIRCUIT (PILOT)		BURNER LOCKOUT
	EXTERNAL FLAME RELAY		UV SENSOR (MAIN)

When two independent sensor are required for dual stage burners, the input at terminal 17 can be configured to receive a contact from an external flame relay used for the 2nd stage burner. When external contact from independent flame surveillance is closed the last indicator of flame signal bar-graph is permanently on (full scale). A flame simulation lockout occurs when a flame is detected by sensor while related fuel valve is closed. Pilot burner flame signal strength reported when only the pilot flame is detected.



WARNING
 The flame sensor wired at terminal 17 must be certified for permanent operation if the main burner remains operative longer than 24 hours. Using a standard flame relay, the main burner must be turned off within 24 hours of continuous operation (non permanent operation of main burner).

Configuration

The device is fully configurable with PC or free software *Qtool* or Q-beam USB device for infrared communication between PC and CFK.

Some parameters are password protected, so that they can be modified by authorized users only.

By means of smartphone app and Q-beam USB is possible to read all the parameters and to set some of them.

SETTABLE PARAMETERS

General Settings	003	BURNER TYPE	GAS OIL	G O
	004	INPUT TERMINAL 17	THERMOSTAT 2 2 nd STAGE FLAME DETECTOR HI-TEMP BYPASS	T F B
	005	AIR PRESSURE SWITCH RESPONSE TIME (default 1")	1" 30"	01 30
Behaviour at Power on – Lockout	101	START-UP MODE	AUTOSTART STANDBY	A S
	102	AIR OUTPUT	ALWAYS OFF ALWAYS ON CONTROLLED FROM P INPUT CONTROLLED FROM BUS	N Y I B
Behaviour during Shutdown	201	MINIMUM BURNER PAUSE TIME (default 0")	0" 250"	000 250
	202	AIR OUTPUT	ALWAYS OFF ALWAYS ON CONTROLLED FROM P INPUT CONTROLLED FROM BUS	N Y I B
All outputs switched off while in manual shutdown				
Behaviour during Purge	301	AIR RUN-UP TIME (default 0")	0" 250"	000 250
	302	AIR OUTPUT	OFF ON	N Y
	303	PREPURGE (WAITING) TIME (default 1")	0" 250"	000 250
Behaviour during Ignition	402	FIRST SAFETY TIME (default 3")	2" 25"	02 25
	403	PILOT BURNER STARTUP ATTEMPTS	1 2 3 4	1 2 3 4
	404	PILOT BURNER FLAME SENSITIVITY USED ALSO FOR DETECTION IN PREPURGE...	1 μ A 9 μ A	1 9
	501	PILOT BURNER PROVING TIME (default 3")	1" 25"	01 25
Behavior during Operation	502	SECOND SAFETY TIME	NO MAIN 1" 5" PILOT REMAINS ACTIVE	0 1 5 C
	503	MAIN BURNER FLAME SENSITIVITY	1 μ A 9 μ A	1 9

	504	FLAME FAILURE	LOCKOUT RECYCLE IGNITION RESTORATION	L C K
	505	FLAME FAILURE RESPONSE TIME (default 1")	1" 12"	01 12
	506	AIR OUTPUT	ALWAYS OFF FOLLOWS PILOT FOLLOWS MAIN FOLLOWS BOTH PILOT & MAIN CONTROLLED FROM P INPUT CONTROLLED FROM BUS	N P M V I B
	507	AIR FAILURE	LOCKOUT RECYCLE	L C
	508	MINIMUM COMBUSTION TIME	0" 25"	00 25
Behavior during Postpurge	601	AIR OUTPUT	OFF ON	N Y
	602	POSTPURGE (WAITING) TIME (default 1")	0" 250"	000 250
Communication Settings	701	ZONE (SEGMENT)	0 ... 9 a ... Z	
	702	UNIT (NODE)	0 ... 9 a ... Z	
	703	BAUD RATE	4800 (default) 9600 19200 38400 57600 ³ 115200 ³	
	704	TIMEOUT ²	DISABLED (default) 1" 50"	

- 1 NON-CONFIGURABLE PARAMETER
 2 INACTIVE WHEN BURNER CONTROL IS OFF
 3 Non suitable for TraxBus

PARAMETERS DESCRIPTION

001 POWER SUPPLY VOLTAGE – hardware parameter – not settable

Power supply voltage for this burner control device and loads (air and fuel valves and ignition transformer) wired at terminal 01 and 02.
 Short circuit and overload protection by internal fuse.
 Optional safety interlock limits could be wired on the main supply phase.

002 PROCESS INPUT VOLTAGE - hardware parameter – not settable

Inputs coming from external control circuit are independent from the main power supply of this device and loads, allowing a different voltage for control interface.
 Inputs referred to a common return at terminal 18 and continuously verified against possible failures, to guarantee a reliable operation.
 The symbols shown near the terminal board are related to input function.

003 BURNER TYPE

Selecting OIL type burner, the ignition device is switched on during the prepurge to allow the detection of fuel leakage that will be ignited, leading to an illegal flame detection. Electrode is not suitable for flame detection in OIL burners.
 Shared rod configuration for OIL burners may damage the unit.

004 INPUT TERMINAL 17

Input at terminal 17 can operate as a

- 2nd stage Start input 2 92 (to switch on/off the main burner), or
- 2nd stage burner flame surveillance input, or
- enable the indirect flame control, disabling flame surveillance when the temperature of furnace walls is above 750°C.

005 AIR PRESSURE SWITCH RESPONSE TIME

The air pressure switch does not follow immediately the status of the air output. This parameter defines the maximum tolerated delay between air output changes and air pressure switch feedback.

101 START-UP MODE

At power-on, once the self-test has been successfully completed, the unit waits in STANDBY mode until a reset operation is performed from push button, input or through a fieldbus remote command. Setting AUTOSTART mode, the cycle starts automatically, unless the units has been turned off while in lockout.

102 AIR OUTPUT DURING POWER-ON & LOCKOUT

To suit different processes you can change the behavior of the air valve (or fan) at power-on and while it is blocking.

It could be kept closed at all times, always open, controlled by P input at terminal 15 or via fieldbus command.

201 MINIMUM BURNER PAUSE TIME

An immediate restart of the burner after a normal shutdown is prevented by the pause time. The pause time starts when the burner is switched off, after post-combustion and post-purge has been deployed (if any).

Any start-up will be ignored until the minimum burner pause time has elapsed.

202 AIR OUTPUT DURING SHUTDOWN

To suit different processes you can change the behavior of the air valve (or fan) output during normal shutdown (91 or fieldbus command request).

It could be kept always closed, always open, controlled by means of P input at terminal 15 or through fieldbus command.

301 AIR RUN-UP TIME

This parameter defines a waiting time to compensate slow opening valves or the initial starting phase of air blowers.

Air pressure switch must be open (air simulation test).

Prepurge starts once the air pressure is detected.

302 AIR OUTPUT DURING PREPURGE

To suit different processes you can change the behavior of the air valve (or fan) output during pre-purge (or waiting time).

Air output could be active or inactive.

303 PURGE TIME

EN298 § 3.124.1 - § 3.124.2 - § 3.124.3 - § 3.124.4

Set purge time in forced draught burners according to applicable and relevant standards (EN 676). During this time the flame simulation test is carried out.

The air output behavior during purge is defined by parameter 302.

This is a merely waiting time if there is no air control.

401 PRE-IGNITION TIME - non-configurable parameter

EN298 § 3.135.3

The ignition transformer is turned on 500 ms before the pilot fuel valve to check the correct operation before supplying the fuel.

This is a fixed time and can not be changed.

402 FIRST SAFETY TIME

EN298 § 3.116

Set the correct time following EN 746-2 (or other relevant) requirements:

Natural draught burners $\leq 350 \text{ kW} \rightarrow 10''$ $> 350 \text{ kW} \rightarrow 5''$
 Ignition power $\leq 33\%$ Nominal Power with maximum of 350 kW

Forced draught burners $\leq 70 \text{ kW} \rightarrow 5''$ $> 70\text{kW} \rightarrow 3''$
 Ignition power $\leq 10\%$ Nominal Power with maximum of 350 kW

403 PILOT BURNER STARTUP ATTEMPTS

EN746-2 - EN676

When the flame is not detected at the end of startup safety time, it's possible to make up to 4 startup attempts (including the first one), if the safety of the application is not impaired, repeating the cycle from the beginning.

A lockout will occur if no flame has formed within programmed attempts.

404 PILOT BURNER FLAME SENSITIVITY

EN298 § 3.107

The minimum detectable flame signal during the ignition trial and when the first stage burner is running, in the range 1 ... 9 μA (maximum signal is 30 μA).

This is the sensitivity used to detect illegal flame during pre-purge and post-purge.

501 PILOT BURNER PROVING TIME

EN298 § 3.151

This time elapses before to begin the next program step so as to give the pilot burner flame enough time to stabilize (the main burner can be turned on only at the end of this time).

Remains in this condition (until shutdown or lockout) if the 2nd stage is disabled.

502 SECOND SAFETY TIME

EN298 § 3.117 - § 3.132 - § 3.133

The setting of safety time is to be determined on the basis of burner capacity and relevant application standard (e.g. EN 746-2, EN 676, NFPA 85 or NFPA 86).

V2 switched on when the safety time starts. V1 is switched off at the end of safety time (interrupted), unless selected for intermittent operation (remains active).

503 MAIN BURNER FLAME SENSITIVITY

EN298 § 3.107

The minimum detectable flame signal when the second stage burner is running, in the range 1 ... 9 μA (maximum signal is 30 μA).

This is the sensitivity used also when both first and second stage are running.

504 FLAME FAILURE

EN298 § 7.101.2.3

Determines the behavior at flame loss during normal burner operation.

For burners with occasionally unstable flame signal a single recycle (including pre-purge) or direct ignition restoration can be attempted. The setting is to be determined on the basis of burner capacity and relevant application standard.

505 FLAME FAILURE RESPONSE TIME

EN298 § 3.105.1 - § 7.101.3.4.3 - § 7.101.3.7

If the flame fails during operation, gas valves are switched off within this safety time that must be in accordance with relevant application standards (default for EN 298 is 1" and must not exceed 5", including valves closing time for EN 746-2).

506 AIR OUTPUT DURING OPERATION

To suit different processes you can change the behavior of the air valve (or fan) output during burner operation. It could follow the pilot and/or main fuel valves, kept always closed, always open, controlled by means of P input at terminal 15 or through fieldbus command.

507 AIR FAILURE DURING OPERATION

Determines the behavior at air loss during normal burner operation.

A single recycle (including pre-purge) can be attempted for burners with occasionally unstable air pressure. The setting is to be determined on the basis of burner capacity and relevant application standard.

508 MINIMUM COMBUSTION TIME

An immediate shutdown of the burner, once ignited, is prevented by the minimum combustion time. Time starts once pilot burner has been successfully ignited (after first safety time). Any shutdown from local thermostat 91 or remote fieldbus command will be ignored until minimum combustion time has elapsed.

509 ALLOWED POST-COMBUSTION TIME

Flame signal allowed for 20" once fuel valves has been closed.
Lockout occurs when the flame is detected after this post-combustion time.
Useful when fuel valves are distant from the burner.

601 AIR OUTPUT DURING POSTPURGE

To suit different processes you can change the behavior of the air valve (or fan) output during post-purge (or waiting time).
Air output could be active or inactive.

602 POSTPURGE TIME

EN298 § 3.124.6

Set post-purge time in forced draught burners according to standards (EN 676). The flame simulation test is carried out during this time.
The air output behavior during post-purge is defined by parameter 601.
This is a merely waiting time if there is no air control.

70x ZONE | UNIT | BAUD RATE | TIMEOUT

701 ZONE belonging the burner control.

702 UNIT belonging the burner control.

All alphanumeric (uppercase/lowercase) characters are valid identifiers

703 BAUD RATE: 4800, 9600, 19200, 38400

704 TIMEOUT: remote host must send a valid message within the specified time interval to prevent lockout. Set from 1 to 50 seconds, 0 to disable.

Fieldbus control

Remote control and supervision of CFK is possible through communication interface using TraxBus™.

TraxBus™ is fieldbus specifically designed for reliable operation in harsh industrial environments with simplified wiring. It uses a multi-drop wire pair and features high electromagnetic noise immunity.

Traxbus of many CFK devices can be connected to a single TraxGateway.ETH. This is a bus converter which allows to control up to 99 burners operated by CFK in a TraxBus network from one PROFINET-IO controller. PROFINET® is a technical standard for data communication over Industrial Ethernet, designed for collecting data from, and controlling equipment in industrial systems in short time.

As alternative, bus of many CFK devices can be connected to a single TraxInterface⁴. TraxInterface⁴ is an active interface converter, it can be set:

-to convert only the “physical” layer of Traxbus (Transparent mode); in this case communication protocol can be easily implemented into any programmable controller with great efficiency and low cost;

-to convert from TraxBus™ to Modbus® ASCII / RTU (Modbus mode). **Modbus®** is a serial communication protocol developed for industrial applications, it is popular because it is royalty-free and openly published.

For further details about TraxGateway.ETH and TraxInterface⁴ see specific datasheets.

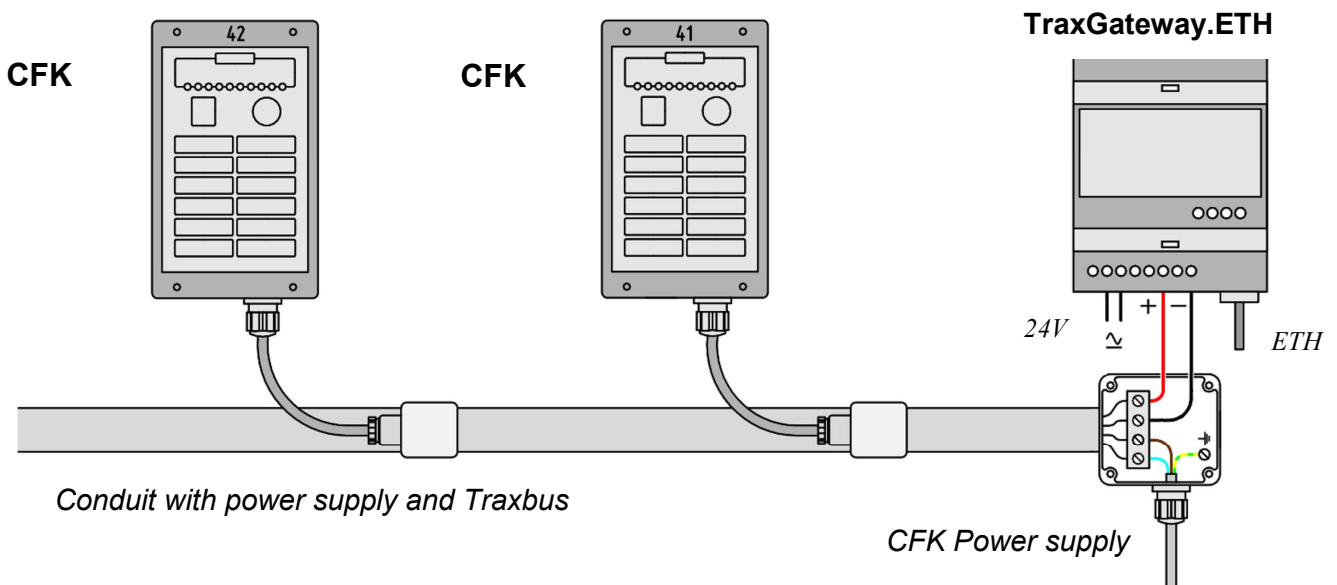

Fig.9



WARNING

Once a valid command is received through the communication line a Led indicator in the front panel will blink yellow. (this indicator will blink once at power-on, during self-diagnosis).

A failure to internal supervision logic occurred when this indicator remains permanently on.

Remove power supply and restart. If the unit still inoperative send it back to factory for servicing.

Installation warnings

Verify receipt of the correct power supply and process inputs voltage, by checking the label.

Holes required for mounting must be made on the back part only. Use cable glands that maintain at least the same IP protection as declared.

In the three-phase systems, use the same phase for inputs. Do not reverse phase with neutral.

The enable command for the flame control, which comes from the safety sequence (all the main safety control devices such as thermostats, fuel pressure switches, tightness control, etc....) must be a non-voltage contact, or it must command an auxiliary relay.

All safety switches should be approved as limit controls. The use of electronic switches may cause erratic operations of the unit.

Output voltage for the automatic fuel valves and the ignition transformer (included, if required) is the same as supply voltage.

Use power, signal and control cable suitable for the type of operation and complying with all regulations. Do not route connections together with frequency converter cables or cables emitting strong fields.

Aluminium enclosures must be connected to PE (protection earth). Provide reliable connection to PE and burner frame, recommended wire gauge > 4 mm².

All electronic systems must be supplied by a dedicated transformer in a TN-S earthing system.

Use unscreened high-voltage cable for ignition and ionization rod lines, laying cables individually, avoiding metal conduits. Keep high voltage ignition cables as short as possible, avoiding loops and keep all other cables, especially those of UV scanner or ionization rod, as far apart as possible.

The air output A3 is suitable to control valves or fan motor within the max rated contact current, add an external relay if necessary. Air, fuel valves and ignition transformer outputs are protected by internal fuse, which must be replaced only with same type and value component.

The outputs at terminals 11 and 12 are SPST unprotected dry contacts, load must be within the rated current.

A jumper must be installed between terminals A1 - A2 when the air pressure switch is not available and air output [VA] is enabled.



WARNING

Disconnect the power supply before proceeding with installation or wiring.

		CFK	10	1	B
Model	CFK				
Type	1 BASIC 2 FULL				
Case	P Plastic M Aluminum				
Supply Voltage	A 230V 50/60Hz B 115V 50/60Hz				
Process inputs (only if different from supply voltage)	A 230V AC B 1115V AC C1 48V AC C 24V AC				

CFK devices are supplied with the following DEFAULT CONFIGURATION:

2	2	G	T	01	A	N	000	N	000	N	001	03	1	2	03	C	2	L	01	N	L	00	N	000		
201	202	003	004	005	101	102	201	202	301	302	303	402	403	404	501	502	503	504	505	506	507	508	601	602		
SUPPLY 230 VAC		INPUTS 230 VAC		FUEL GAS	THERMOSTAT 2	AIR RESPONSE TIME 1	AUTOSTART	AIR OUTPUT OFF	MIN PAUSE TIME 0	AIR OUTPUT OFF	AIR RUN-UP TIME 0	AIR OUTPUT OFF	PREPURGE TIME 1	1 ST SAFETY TIME 3	STARTUP ATTEMPTS 1	FLAME SENSITIVITY 2	1 ST PROVING TIME 3	2 ND SAFETY TIME NO	FLAME SENSITIVITY 2	FLAME FAILURE LOCK	FLAME FAILURE TIME 1	AIR OUTPUT OFF	AIR FAILURE LOCK	MIN COMBUSTION TIME 0	AIR OUTPUT OFF	POSTPURGE 0
GENERAL					LCK		SHUT		PURGE			IGNITION					OPERATION					PURGE				

201 hardware parameter, deriving from ordering code

Variation of parameters 003 .. 602 must be requested in the order and will be set in the factory.

Alternatively, parameters 003 .. 602 can be set using Qtool + USB device (see pag. 14).

Configuration parameters are shown on the product label.

Accessories

UV4 SH

High performance selected UV flame detector that can be used for flame detection in gas, oil and mixed burners together with suitable burner control unit or flame amplifier device.



Fig.10

Q-beam

Q-beam is the device to set a CFK burner control using a PC with USB port and Qtool software. Qtool is supplied together with Q-beam.

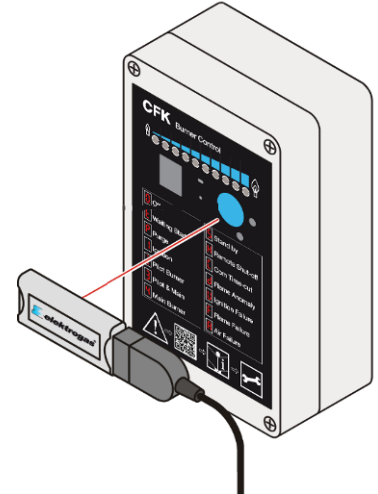

Fig.11

TraxGateway.ETH

TraxGateway.ETH is a converter to manage till 99 burners controlled by CFK in a TraxBus net with a PROFINET-IO controller.



Fig.12

TraxInterface⁴

TraxInterface⁴ is an active interface converter from TraxBus™ to the physical layers EIA-RS232 or EIA-RS485.

TraxInterface⁴ can operate in two different modes: Transparent or Modbus® ASCII / RTU.



Fig.13

Refer to specific device datasheets for details.

Standards and approvals

The product complies with the essential requirements of the following European Directives and their amendments:



2016/426/EU (Gas Appliances Regulation)
2014/30/EU (Electromagnetic Compatibility)
2014/35/EU (Low Voltage Directive)
2011/65/EU (RoHS II)

CE-Reg.-No. **0063CS1560**

The product complies with the requirements of EN 746-2 and gives an equivalent level of safety according to EN 298.

Since EN 298 does not describe all functions of CFK – implemented to manage all possible industrial scenarios – the operator is responsible for ensuring that parameters and functions are appropriate for the application. Certification applies only for options and values allowed by EN 298.



The product complies with the Technical Regulations TP TC 004/2011-016/2011-020/2011 of Russia, Belarus and Kazakhstan.

Declaration of Conformity: **UEE N RU Д-IT.PA02.B.05041/22**

Sistema di Gestione della Qualità certificato secondo la norma UNI EN ISO 9001.



Elektrogas is a brand name of:

Elettromeccanica Delta S.p.A.
Via Trieste 132
31030 Arcade (TV) – ITALY

The information in this document contains general descriptions of technical options available and based on current specifications.

The company reserves the right to make changes in specifications and models as design improvements are introduced, without prior notice.

tel +39 0422 874068
fax +39 0422 874048
www.delta-elektrogas.com
info@delta-elektrogas.com

Copyright © 2022
All rights reserved